

7962 BODY

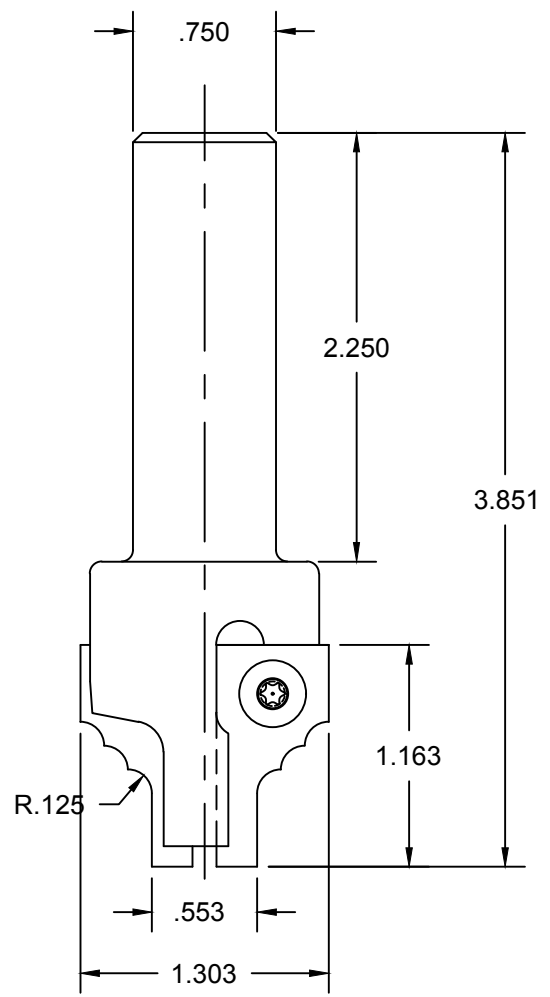

INS-8192

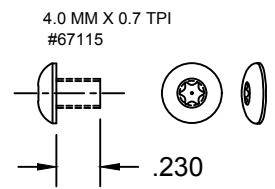
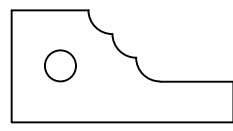

NOTES:



DATE: 07-17-18
REV. #: -

REV	REVISIONS	APPROVAL DATE:	TOLERANCES UNLESS SPECIFIED		PROPRIETARY INFORMATION WARNING THIS DRAWING AND ITS CONTENTS ARE THE PROPERTY OF VORTEX TOOL CO. INC. AND MAY NOT BE USED, COPIED, OR DISCLOSED TO OUTSIDE PARTIES WITHOUT WRITTEN CONSENT FROM VORTEX TOOL, INC	CUSTOMER: VORTEX TOOL	
			FRACTIONAL +/- 1/64	BREAK ALL CORNERS NOT REQUIRED TO BE SHARP		TIP MATERIAL: -	BODY UNDER: -
			DECIMAL +/- .005	WORK TO LATEST ENGINEERING CHANGE		COMP. DRWG. SIZE: -	O.D. CL. -
			ANGULAR +/- 1°			DRAWN BY: MORGAN	APPROVED BY: BRIAN