

8230 BODY

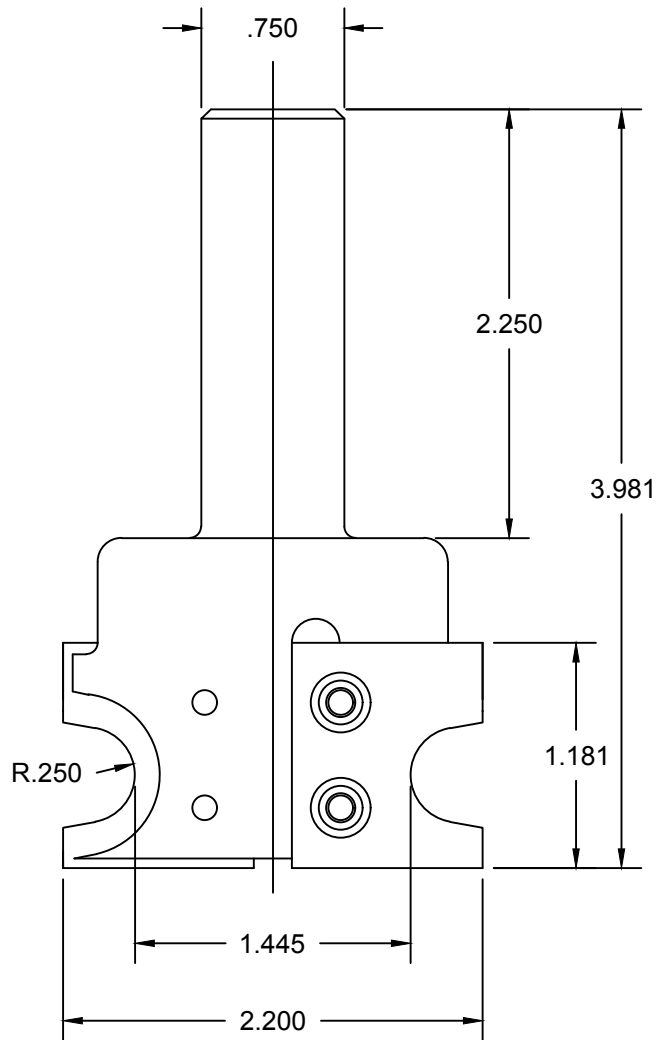

INS-8230

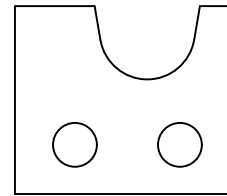

4.0 MM X 0.7 TPI
#67115

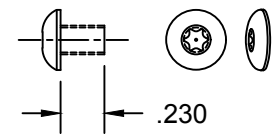

NOTES:

VORTEX
TOOL COMPANY INC.

DATE: 07-17-18

REV. #: -

CUSTOMER: VORTEX TOOL

REV	REVISIONS	APPROVAL DATE:

TOLERANCES UNLESS SPECIFIED	
FRACTIONAL +/- 1/64	BREAK ALL CORNERS NOT REQUIRED TO BE SHARP
DECIMAL +/- .005	WORK TO LATEST ENGINEERING CHANGE
ANGULAR +/- 1°	

PROPRIETARY INFORMATION WARNING
THIS DRAWING AND ITS CONTENTS ARE THE PROPERTY OF VORTEX TOOL CO. INC. AND MAY NOT BE USED, COPIED, OR DISCLOSED TO OUTSIDE PARTIES WITHOUT WRITTEN CONSENT FROM VORTEX TOOL, INC

TIP MATERIAL: -

BODY UNDER: -

COMP. DRWG. SIZE: -

O.D. CL. -

DRAWN BY: MORGAN

APPROVED BY: BRIAN